

# Modular Multiples®

## Layered

Surface Mounted - New/Old Work

Outstanding flexibility and design excellence in surface mounted configurations for applications where ceilings are currently installed. Can be wall, ceiling, canopy or pendent mounted with 1/16" braided stainless steel cables.

### Four Lamp Square



MLS-4-D-6-TI-RDSQ-SM

Modular Multiples® Surface Layered Series, four AR111 lamps, stainless steel plates, transformer incorporated, round apertures/square arrangement, surface mounted configuration. Other configurations available.

[Download CSI drop-in spec template](#)

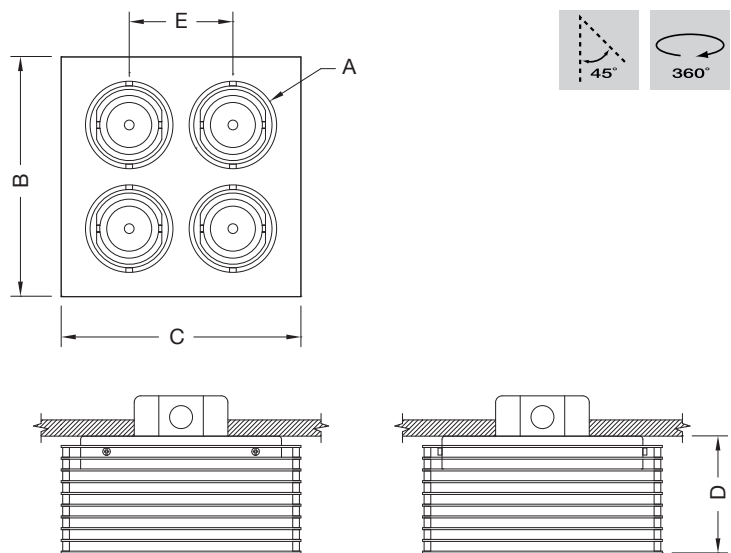

LAMPS and DIMENSIONS	A	B	C	D	E
LED506, LED513 / MR16LED / MR16	Ø3-3/8" Ø86mm	9-1/4" 235mm	9-1/4" 235mm	4-1/2" 115mm	4" 102mm
LED708, 714, 716, 930 / AR111LED / AR111	Ø7" Ø178mm	1'4-15/16" 430mm	1'4-15/16" 430mm	4-1/2" 115mm	4" 102mm

# Modular Multiples®

The Original Multiple Lamp Family of Fixtures

5

## Layered

Surface Mounted - New/Old Work



- Configurations:**
- 1, 2, 3, 4 light configurations standard
  - Round apertures standard
  - Custom configurations available

**Housing:** 14 gauge laser cut stainless steel plates

- Finishes:**
- Stainless steel / satin nickel standard
  - Powder coated custom colors available

- Electrical:**
- Internal electronic power supply(s) /transformer(s) / ballast(s)
  - Dimmable (not applicable on HID products)
  - One power supply / transformer per lamp allowing for multi-circuit wiring.
  - 120v and 277v available
  - Listed to UL1598 standards

[Download CSI drop-in spec template](#)

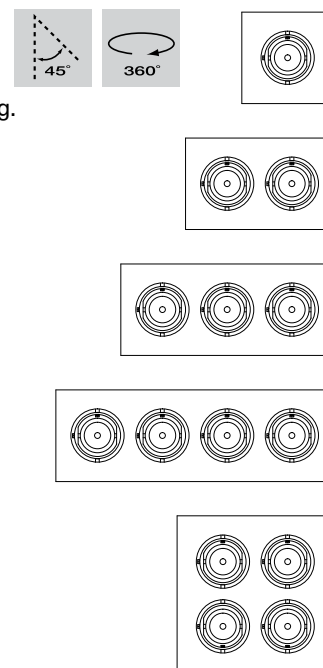

**Lamping:**

**Standard LED Modules**

6w LED-506-6	12w LED-512-12	12w LED-512-22
8w LED-708-6	14w LED-714-12	14w LED-714-22
16w LED-716-12	16w LED-716-22	16w LED-716-45
30w LED-930-12	30w LED-930-22	30w LED-930-45

**Direct Replacement LED or Legacy Lamps:**

MR16LED (BLD)	MR16 HALOGEN (B)	MR16CMH (BH)
AR111LED (DLD)	AR111 HALOGEN (D)	CDMR111 (S)
PAR30LED (GLD)	PAR30 (G)	PAR30HID (H)
PAR38LED (JLD)	PAR38 (J)	PAR38HID (K)

**Mounting:**

- For applications where ceilings are currently installed.
- Can be wall, ceiling, canopy or pendent mounted with 1/16" braided stainless steel cables.
- Secure to ceiling or wall structure with the appropriate hardware.

**Options:**

- Patented die-cast aluminum ring sets and locking devices
- Shielding cones
- Filter media
  - LED modules accept one 1/8" thick filter
  - LED direct replacement and legacy lamps accept up to two 1/8" thick filters

**Model # example:**

**MLS-2-LED/30-6-TI-RD-SM**

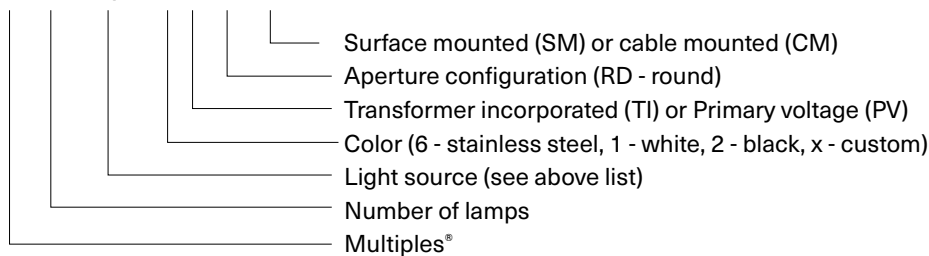

# Modular Multiples®

## Surface Layered Surface Mounted



## Mounting Options

SURFACE MOUNTING

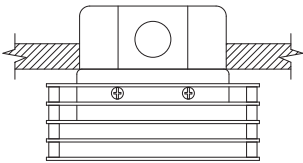

CABLE MOUNTING

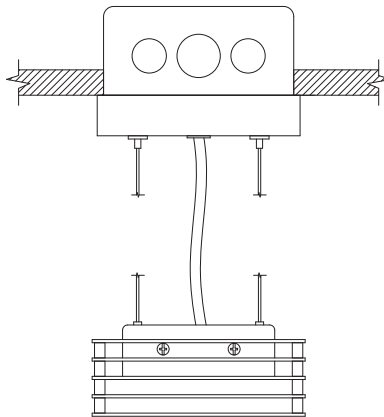

STEM MOUNTING

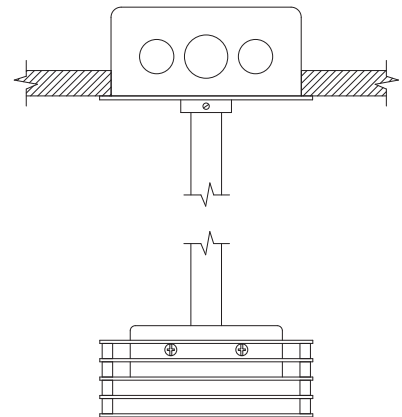

# Modular Multiples®

The Original Multiple Lamp Family of Fixtures



## Standard LED Modules

### LED-506-6

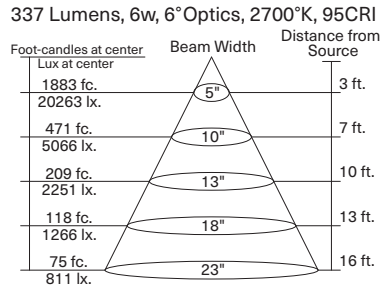

### LED-512-12

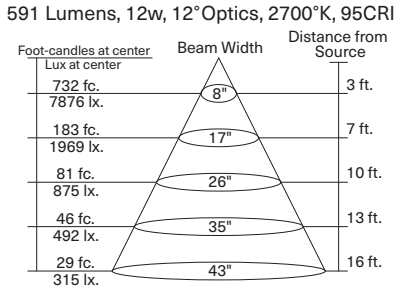

### LED-512-22

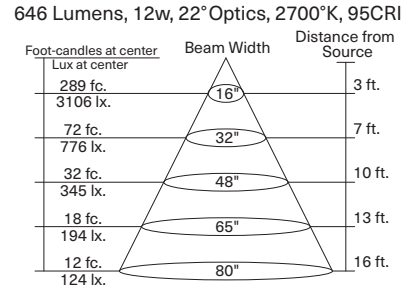

### LED-708-6

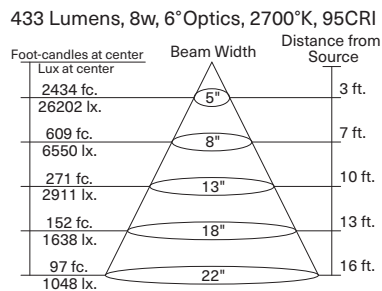

### LED-714-12

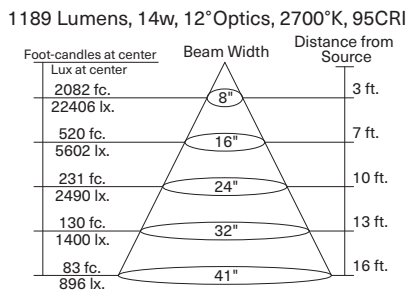

### LED-714-22

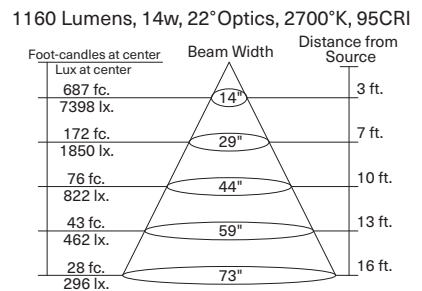

### LED-716-12

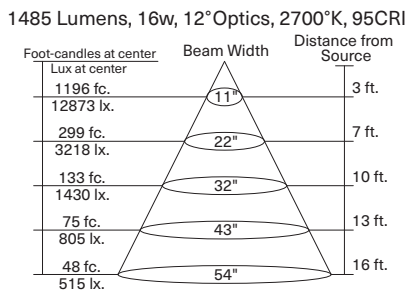

### LED-716-22

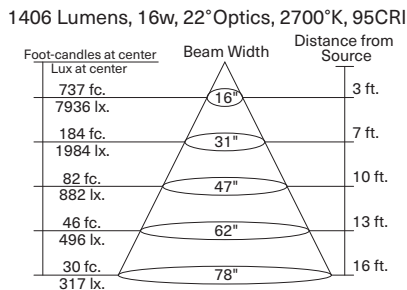

### LED-716-45

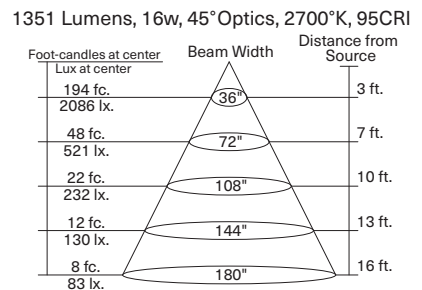

### LED-930-12

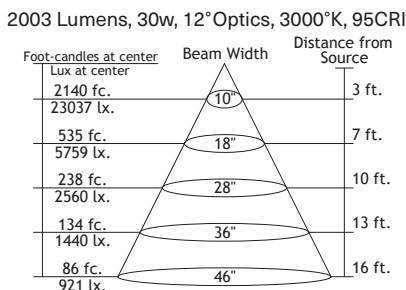

### LED-930-22

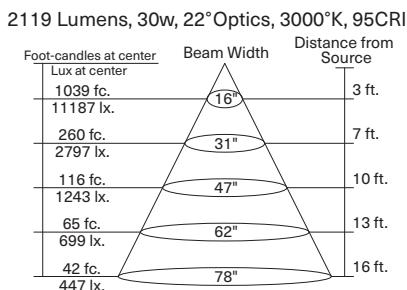

### LED-930-45

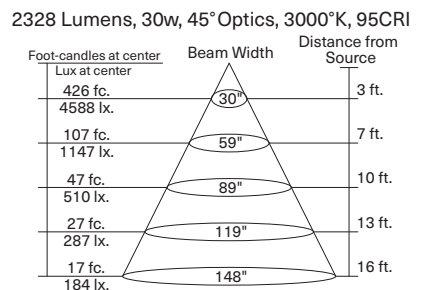

# Modular International, Inc.



## Elements™ 16w LED Module

16<sub>w</sub>

**Model :** LED-516

**Wattage:** 16

**Lumens:** 640 at 3000°K

**Kelvin Temperature:** 2850°K or 3000°K (+/- 2%)

**Standard CRI:** 95

**Accessories and customization available:** Tuning, dimming, beam angles, Kelvin temperature, shielding and filtering

**Beam Angles:** 14° Spot, 21° Narrow Flood, 34° Flood, 6° beam angle also available

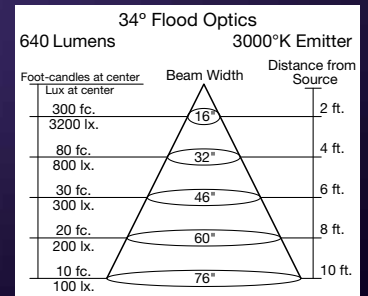
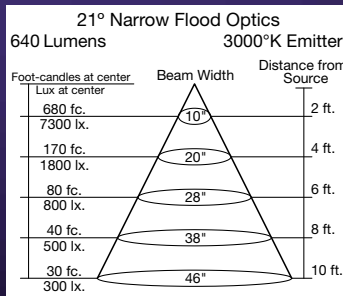
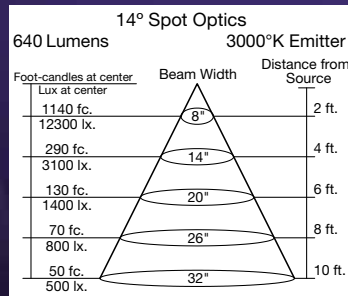

## Elements™ 30w LED Module

30<sub>w</sub>

**Model :** LED-530

**Wattage:** 30

**Lumens:** 1200 at 3000°K

**Kelvin Temperature:** 2850°K or 3000°K (+/- 2%)

**Standard CRI:** 95

**Accessories and customization available:** Tuning, dimming, beam angles, Kelvin temperature, shielding and filtering

**Beam Angles:** 14° Spot, 21° Narrow Flood, 34° Flood, 6° beam angle also available

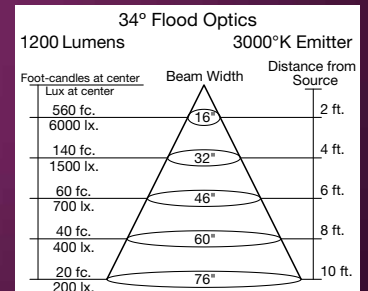
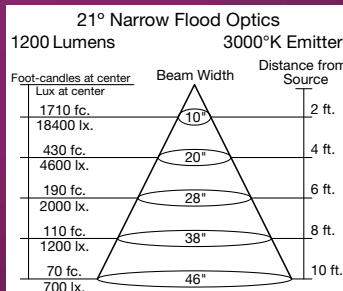
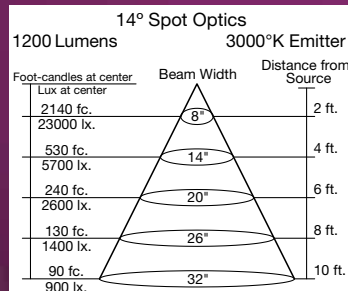

# Modular Multiples®

## Fixture Options

Modular accessories are used individually or in inventive combinations to shield brightness, reduce glare, vary beam patterns, retain direction, and alter color. Dimensions of all fixture options vary with lamp size.

### Ring Sets and Locking Devices (PATENTED)

ADD -LM TO END OF MODEL NUMBER

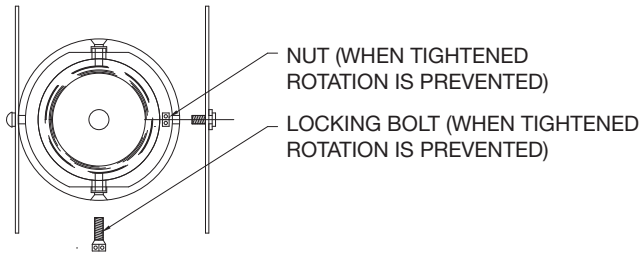

**BOTTOM VIEW**

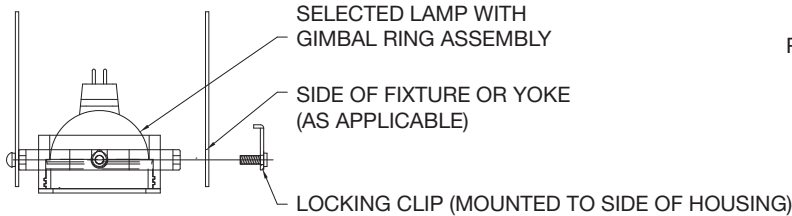

**FRONT VIEW**

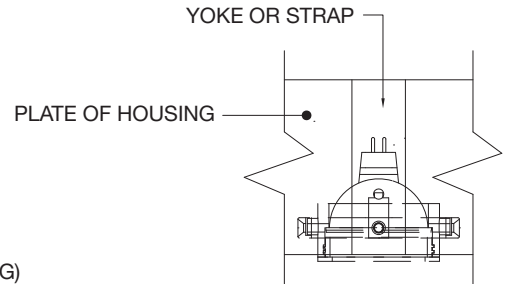

**SIDE VIEW**

### Shielding Options

ADD SHIELDING OPTION CODE (BELOW) TO END OF MODEL NUMBER

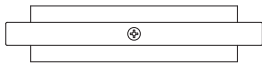

**FILTER RING (STANDARD)**

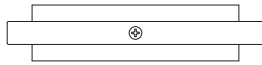

**SHIELDING CONE (-SC)**

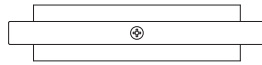

**SHIELDING CYLINDER (-CY)**

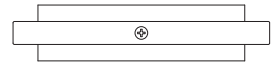

**WALL WASH CONE (-WWC)**

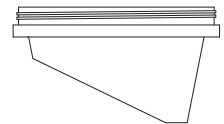
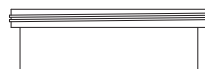
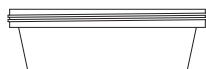

# Modular Multiples®

## Fixture Options

Modular accessories are used individually or in inventive combinations to shield brightness, reduce glare, vary beam patterns, retain direction, and alter color. Dimensions of all fixture options vary with lamp size.

### Filter Media

ADD FILTER MEDIA CODE (BELOW) TO END OF MODEL NUMBER

LED modules accept one 1/8" thick filter. LED direct replacement and legacy lamps accept up to two 1/8" thick filters.

CLEAR  
GLASS (-CG)

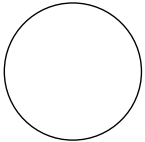

DIFFUSING  
SPREAD (-DS)

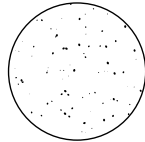

CUBE CELL  
LOUVER (-CL)

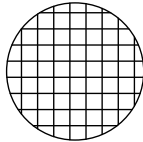

HEXCELL  
LOUVER (-HL)

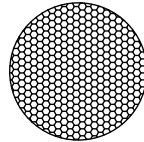

LINEAR  
SPREAD (-LS)

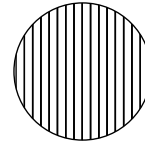

PRISMATIC WIDE  
SPREAD (-PS)

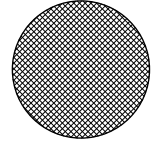

SATIN ETCHED  
(-SE)

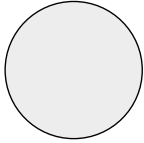

UV BLOCKING  
(-UB)

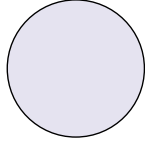

DICHROIC

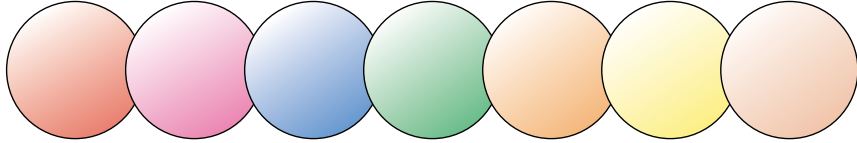

RED  
(-DR)

MAGENTA  
(-DM)

BLUE  
(-DB)

GREEN  
(-DG)

AMBER  
(-DA)

YELLOW  
(-DY)

PEACH  
(-DP)