

Modular Multiples®

Grid

Surface Mounted - New/Old Work

Two Lamp

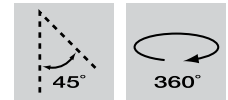
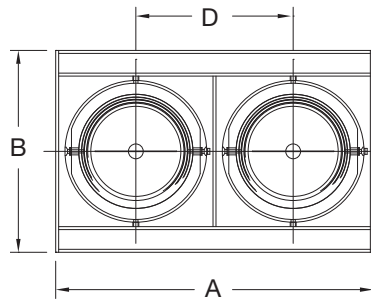

MGS2DLD1TI-REC-WM Modular Multiples® Grid Series, 2 AR111 LED lamps, white, transformer incorporated, rectangular grid, wall mounted configuration shown. Other configurations available.

[Download CSI drop-in spec template](#)

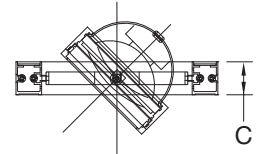
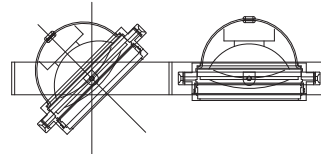

LAMPS and DIMENSIONS	A	B	C	D
LED506, 513 MR16LED / MR16	7-7/8" / 200mm	6" / 152mm	1-3/8" / 35mm	3-7/8" / 98mm
LED708, 714, 716, 930 AR111LED / AR111	1' 1-3/8" / 340mm	8-1/2" / 216mm	1-3/8" / 35mm	6-5/8" / 168mm
PAR38LED / PAR38	1' 2-3/4" / 375mm	9-11/32" / 238mm	1-3/8" / 35mm	7-5/16" / 186mm

Modular Multiples®

The Original Multiple Lamp Family of Fixtures

7

Grid

Surface Mounted - New/Old Work



- Configurations:**
- 2, 3, 4 light units standard
 - Custom available

Housing: Extruded and waterjet cut aluminum components

- Finishes:**
- Powder coated white, black and aluminum standard
 - Powder coated custom colors available

- Electrical:**
- Internal electronic power supply(s) / transformer(s) / ballast(s)
 - Dimmable (not applicable on HID products)
 - One power supply / transformer per lamp allowing for multi-circuit wiring
 - 120v and 277v available
 - Listed to UL1598 standards

[Download CSI drop-in spec template](#)



Lamping: **Standard LED Modules**

6w LED-506-6	12w LED-512-12	12w LED-512-22
8w LED-708-6	14w LED-714-12	14w LED-714-22
16w LED-716-12	16w LED-716-22	16w LED-716-45
30w LED-930-12	30w LED-930-22	30w LED-930-45

Direct Replacement LED or Legacy Lamps:

MR16LED (BLD)	MR16 HALOGEN (B)	MR16CMH (BH)
AR111LED (DLD)	AR111 HALOGEN (D)	CDMR111 (S)
PAR30LED (GLD)	PAR30 (G)	PAR30HID (H)
PAR38LED (JLD)	PAR38 (J)	PAR38HID (K)

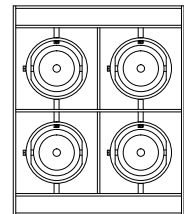
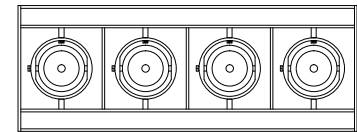
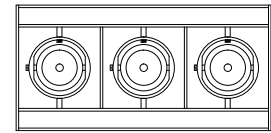
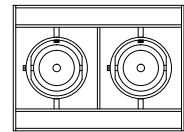

- Mounting:**
- For applications where ceilings are currently installed.
 - Can be wall, ceiling, canopy or pendent mounted with 1/16" braided stainless steel cables.
 - Secure to ceiling or wall structure with the appropriate hardware.

- Options:**
- Patented die-cast aluminum ring sets and locking devices
 - Shielding cones
 - Filter media
 - LED modules accept one 1/8" thick filter
 - LED direct replacement and legacy lamps accept up to two 1/8" thick filters

Model # example:

MGS-4-LED/30-1-TI-SQ-CM

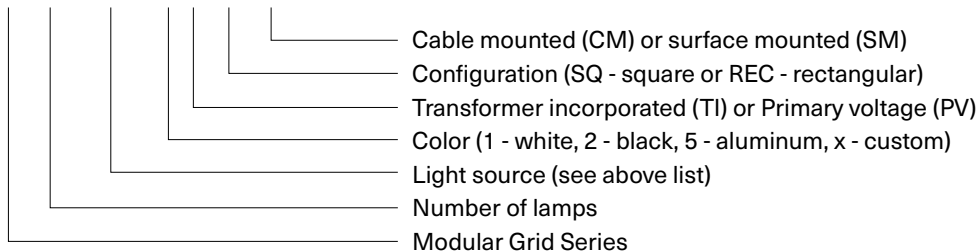

Modular Multiples®

The Original Multiple Lamp Family of Fixtures



Standard LED Modules

LED-506-6

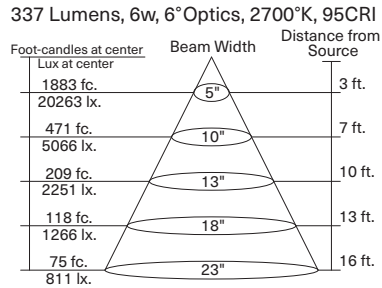

LED-512-12

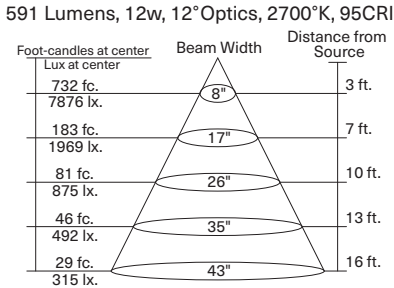

LED-512-22

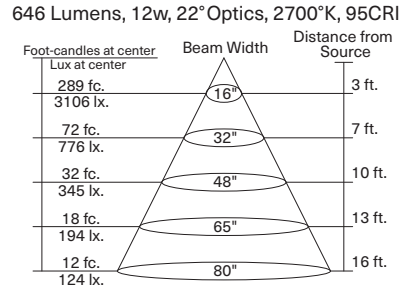

LED-708-6

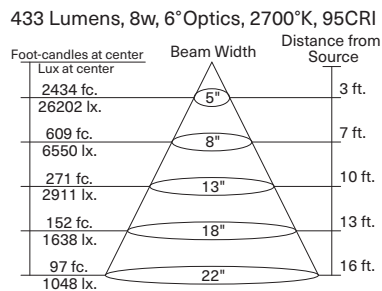

LED-714-12

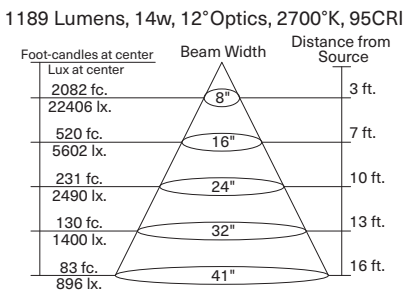

LED-714-22

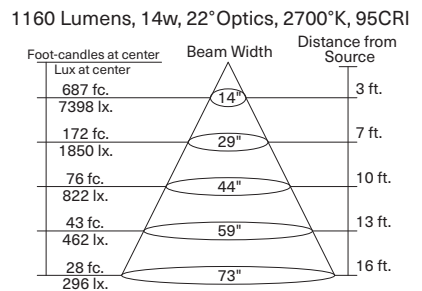

LED-716-12

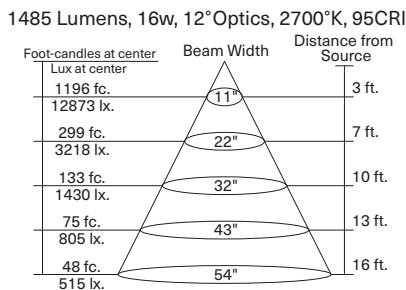

LED-716-22

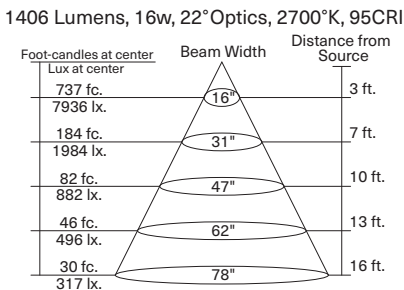

LED-716-45

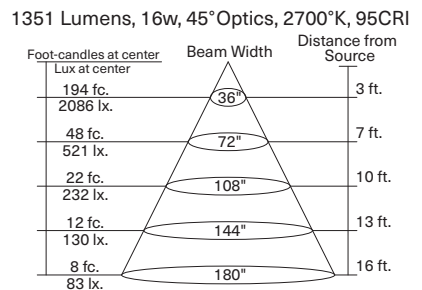

LED-930-12

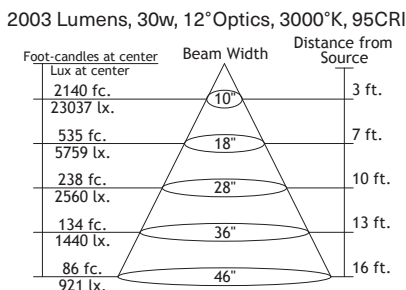

LED-930-22

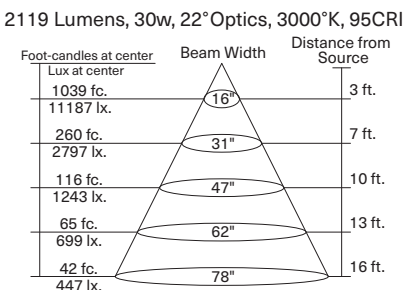

LED-930-45

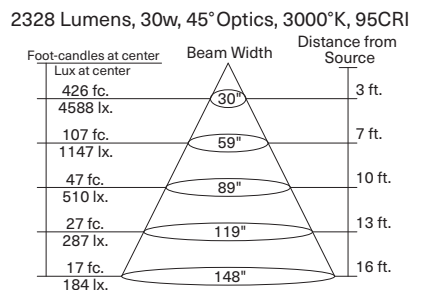

Modular International, Inc.



Elements™ 16w LED Module

16_w

Model : LED-516

Wattage: 16

Lumens: 640 at 3000°K

Kelvin Temperature: 2850°K or 3000°K (+/- 2%)

Standard CRI: 95

Accessories and customization available: Tuning, dimming, beam angles, Kelvin temperature, shielding and filtering

Beam Angles: 14° Spot, 21° Narrow Flood, 34° Flood, 6° beam angle also available

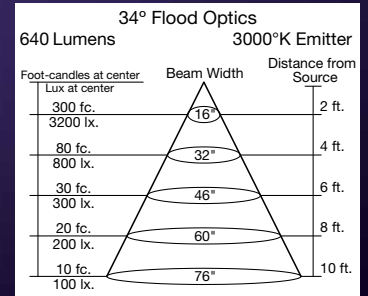
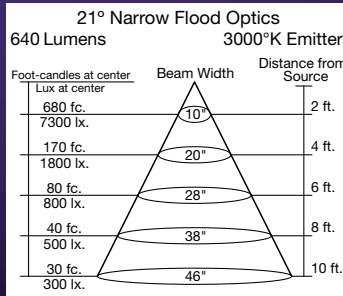
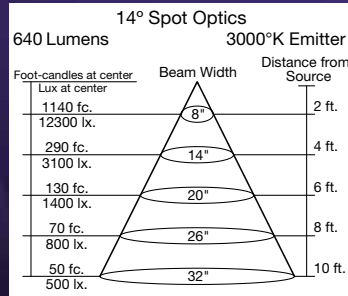

Elements™ 30w LED Module

30_w

Model : LED-530

Wattage: 30

Lumens: 1200 at 3000°K

Kelvin Temperature: 2850°K or 3000°K (+/- 2%)

Standard CRI: 95

Accessories and customization available: Tuning, dimming, beam angles, Kelvin temperature, shielding and filtering

Beam Angles: 14° Spot, 21° Narrow Flood, 34° Flood, 6° beam angle also available

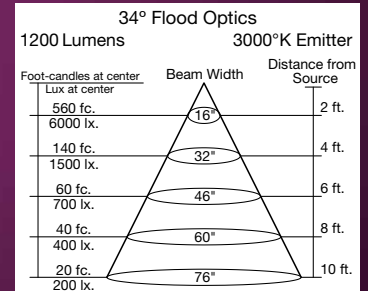
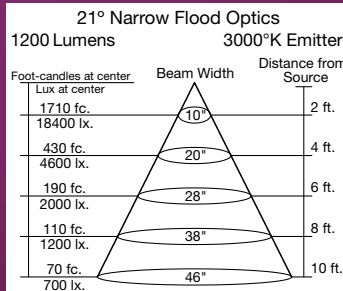
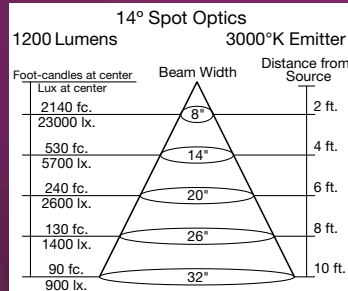

Modular Multiples®

Grid

Typical Installation

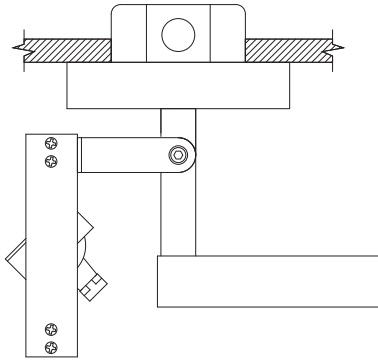

SURFACE MOUNTING

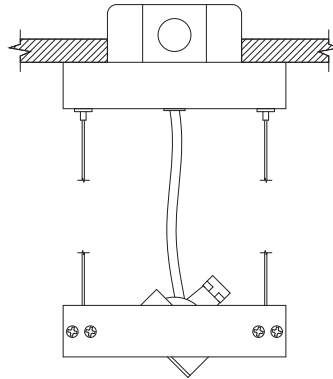

CABLE MOUNTING

Fixture Options

Modular accessories are used individually or in inventive combinations to shield brightness, reduce glare, vary beam patterns, retain direction, and alter color. Dimensions of all fixture options vary with lamp size.

Ring Sets and Locking Devices (PATENTED)

ADD -LM TO END OF MODEL NUMBER

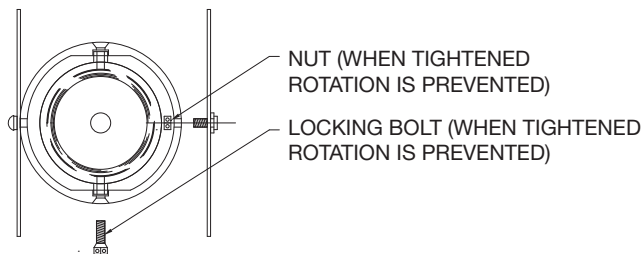

NUT (WHEN TIGHTENED
ROTATION IS PREVENTED)

LOCKING BOLT (WHEN TIGHTENED
ROTATION IS PREVENTED)

BOTTOM VIEW

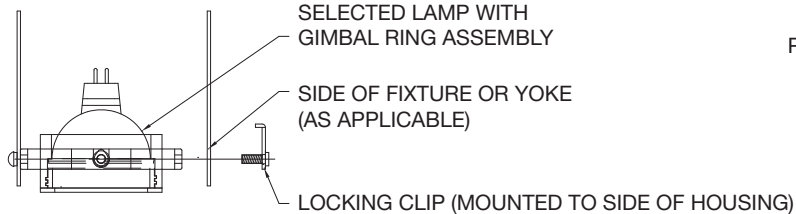

SELECTED LAMP WITH
GIMBAL RING ASSEMBLY

SIDE OF FIXTURE OR YOKE
(AS APPLICABLE)

LOCKING CLIP (MOUNTED TO SIDE OF HOUSING)

FRONT VIEW

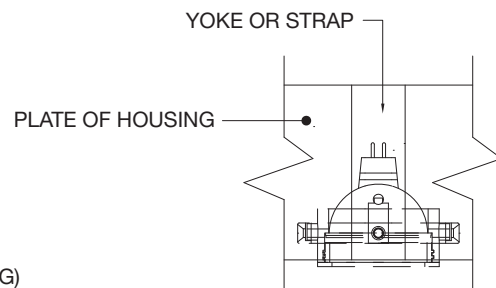

YOKE OR STRAP

PLATE OF HOUSING

SIDE VIEW

Modular Multiples®

The Original Multiple Lamp Family of Fixtures

Fixture Options

Modular accessories are used individually or in inventive combinations to shield brightness, reduce glare, vary beam patterns, retain direction, and alter color. Fixture option dimensions vary with lamp size.

Shielding Options

ADD SHIELDING OPTION CODE (BELOW) TO END OF MODEL NUMBER

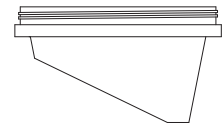
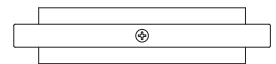
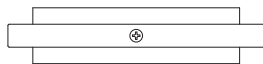

FILTER RING (STANDARD)

SHIELDING CONE (-SC)

SHIELDING CYLINDER (-CY)

WALL WASH CONE (-WWC)

Filter Media

ADD FILTER MEDIA CODE (BELOW) TO END OF MODEL NUMBER

LED modules accept one 1/8" thick filter. LED direct replacement and legacy lamps accept up to two 1/8" thick filters.

CLEAR GLASS (-CG)

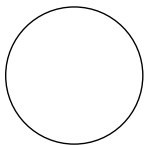

DIFFUSING SPREAD (-DS)

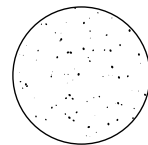

CUBE CELL LOUVER (-CL)

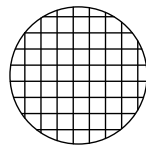

HEXCELL LOUVER (-HL)

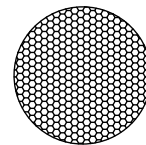

LINEAR SPREAD (-LS)

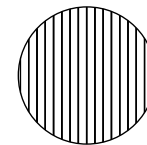

PRISMATIC WIDE SPREAD (-PS)

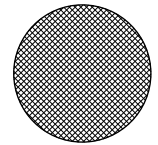

SATIN ETCHED (-SE)

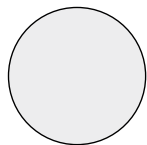

UV BLOCKING (-UB)

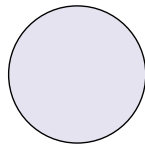

DICHROIC

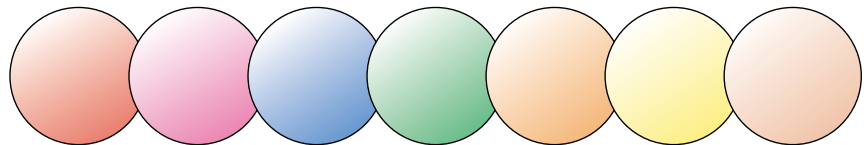

RED (-DR)

MAGENTA (-DM)

BLUE (-DB)

GREEN (-DG)

AMBER (-DA)

YELLOW (-DY)

PEACH (-DP)