

Modular Multiples®

Surface Solid Surface Mounted

Outstanding flexibility and design excellence in surface mounted configurations for applications where ceilings are currently installed. Can be wall, ceiling, canopy or pendent mounted with 1/16" braided stainless steel cables.

Custom Mixed Lamp

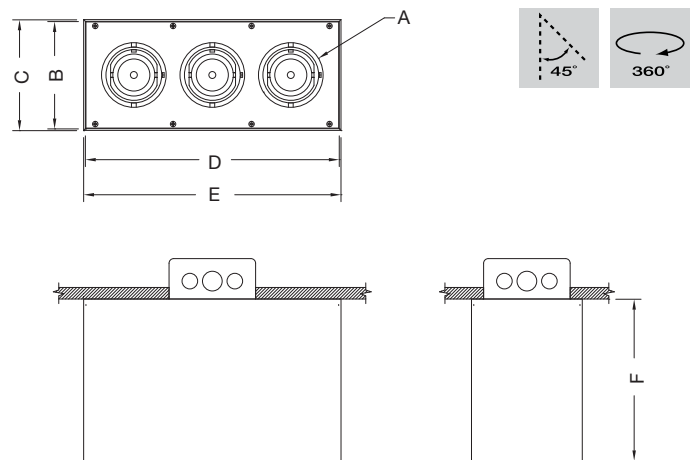

MS-2D1H-1-TI-RD-SM

Modular Multiples® Surface Solid Series, custom two AR111 lamps, one PAR30HID lamp, white housing, transformer incorporated, round aperture, surface mounted configuration. Other configurations available.

LAMPS and DIMENSIONS	A	B	C	D	E	F
LED513 / MR16LED / MR16	Ø3-1/2" Ø89mm	5-13/16" 148mm	6" 152mm	1'1-3/4" 349mm	1'1-15/16" 354mm	8-3/4" 222mm
LED708,716,720 / AR111LED / AR111	Ø6-1/2" Ø165mm	8-13/16" 224mm	9" 229mm	1'11-5/16" 592mm	1'11-1/2" 597mm	8-3/4" 222mm
PAR38LED / PAR38	Ø7" Ø178mm	9-13/16" 249mm	10" 254mm	2'4-13/16" 732mm	2'5" 737mm	8-3/4" 222mm

Modular Multiples®

Surface Solid Surface Mounted



- Configurations:**
- 1, 2, 3, 4 light configurations standard
 - round apertures standard
 - custom configurations available
- Housing:** Extruded aluminum body and 14 gauge steel face plate

- Finishes:**
- Powder coated – white, black or aluminum standard
 - Custom colors available
 - Stainless steel / satin nickel available

- Electrical:**
- Internal electronic power supply(s) / transformer(s) / ballast(s)
 - Dimmable (not applicable on HID products)
 - One power supply / transformer per lamp allowing for multi-circuit wiring
 - 120v and 277v available
 - Listed to UL1598 standards

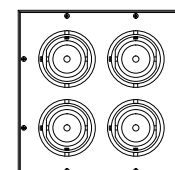
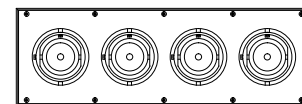
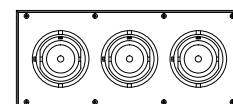
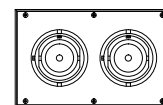
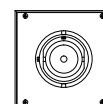

Lamping:

Standard LED Modules

13w LED-513-6	13w LED-513-12	13w LED-513-22
8w LED-708-6	8w LED-708-12	8w LED-708-22
16w LED-716-12	16w LED-716-22	16w LED-716-45
20w LED-720-12	20w LED-720-22	20w LED-720-45

Direct Replacement LED or Legacy Lamps:

MR16LED (-BLD)	MR16 HALOGEN (-B)	MR16CMH (-BH)
AR111LED (-DLD)	AR111 HALOGEN (-D)	CDMR111 (-S)
PAR30LED (-GLD)	PAR30 (-G)	PAR30HID (-H)
PAR38LED (-JLD)	PAR38 (-J)	PAR38HID (-K)

Mounting:

- For applications where ceilings are currently installed.
- Can be wall, ceiling, canopy or pendent mounted with 1/16" braided stainless steel cables.
- Secure to ceiling or wall structure with the appropriate hardware

Options:

- Patented die-cast aluminum ring sets and locking devices
- Pull down yokes (surface solid only)
- Shielding cones
- Filter media
 - LED modules accept one 1/8" thick filter
 - LED direct replacement and legacy lamps accept up to two 1/8" thick filters

Model # example: MS 2 LED-513-6 x TI - RD - SM

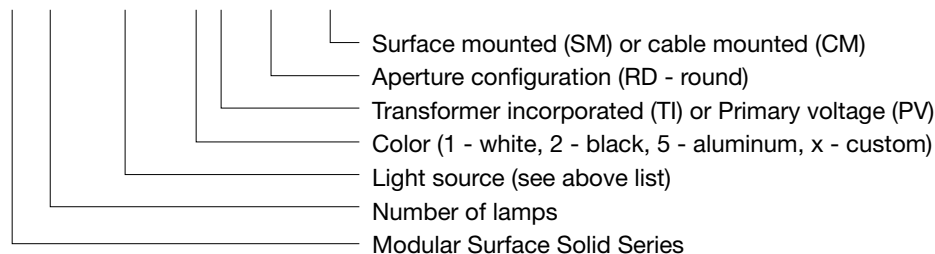

Modular Multiples®

Surface Solid

Surface Mounted - Typical Installation

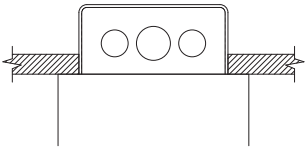

SURFACE MOUNTING

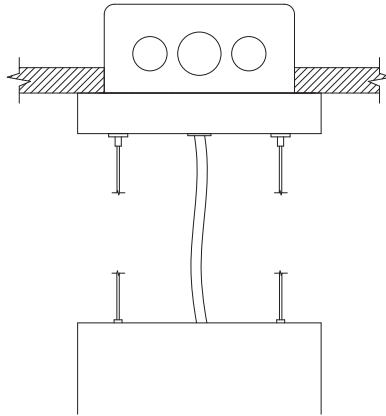

CABLE MOUNTING

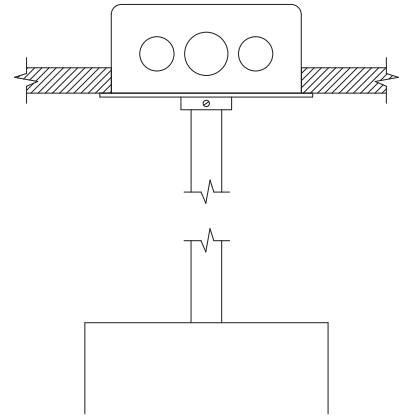

STEM MOUNTING

Modular Multiples®

Standard LED Modules

LED-513-6

623 Lumens 13w / 6° OPTICS / 2700°K

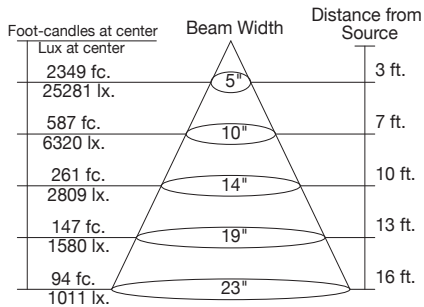

LED-708-6

465 Lumens 8w / 6° OPTICS / 2700°K

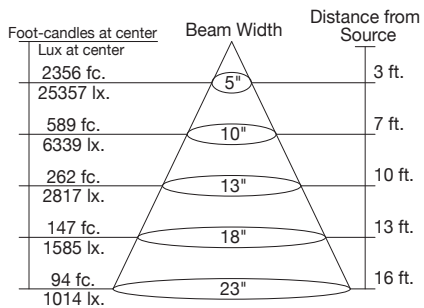

LED-716-12

1047 Lumens 16w / 12° OPTICS / 2700°K

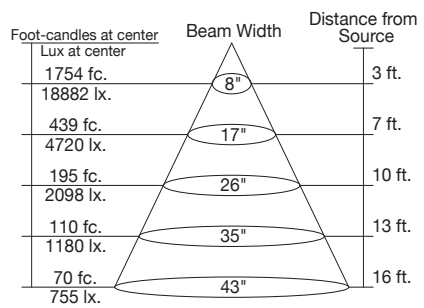

LED-720-12

1054 Lumens 20w / 12° OPTICS / 2700°K

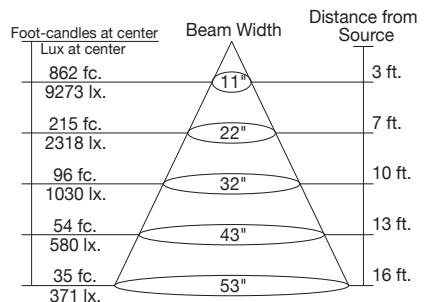

LED-513-12

598 Lumens 13w / 12° OPTICS / 2700°K

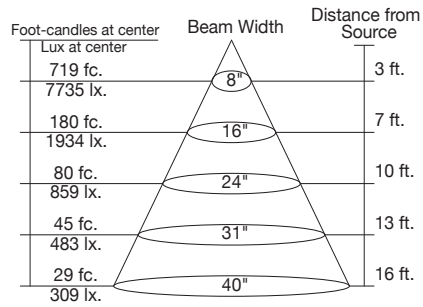

LED-708-12

626 Lumens 8w / 12° OPTICS / 2700°K

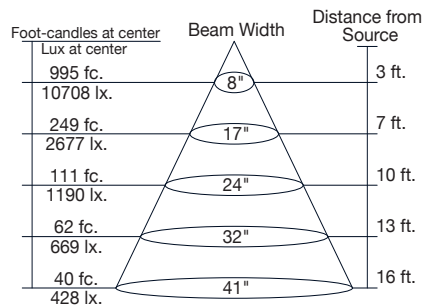

LED-716-22

1043 Lumens 16w / 22° OPTICS / 2700°K

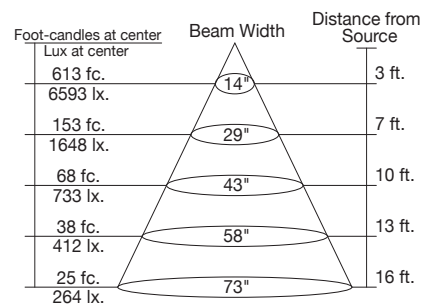

LED-720-22

1040 Lumens 20w / 22° OPTICS / 2700°K

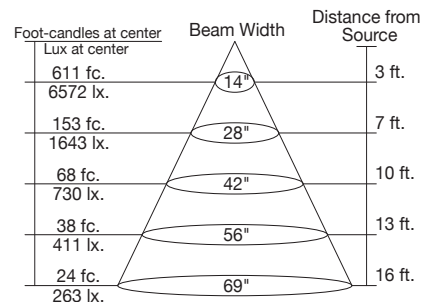

LED-513-22

630 Lumens 13w / 22° OPTICS / 2700°K

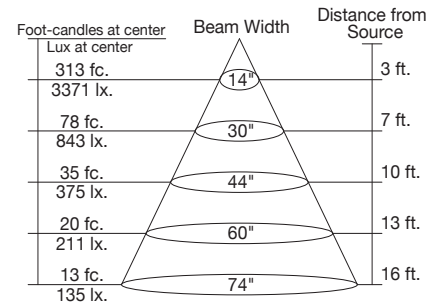

LED-708-22

613 Lumens 8w / 22° OPTICS / 2700°K

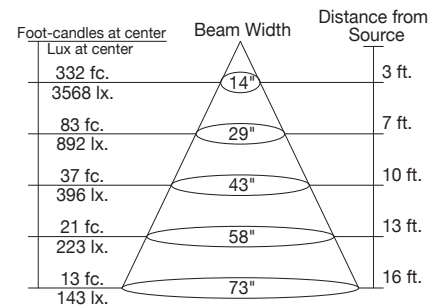

LED-716-45

980 Lumens 16w / 45° OPTICS / 2700°K

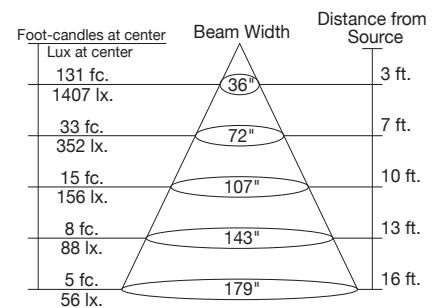

LED-720-45

1033 Lumens 20w / 45° OPTICS / 2700°K

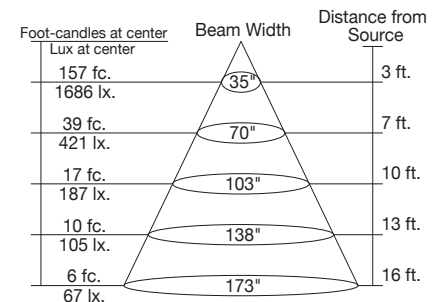

Modular Multiples®

Fixture Options

Modular accessories are used individually or in inventive combinations to shield brightness, reduce glare, vary beam patterns, retain direction, and alter color. Dimensions of all fixture options vary with lamp size.

Ring Sets and Locking Devices (PATENTED)

ADD -LM TO END OF MODEL NUMBER

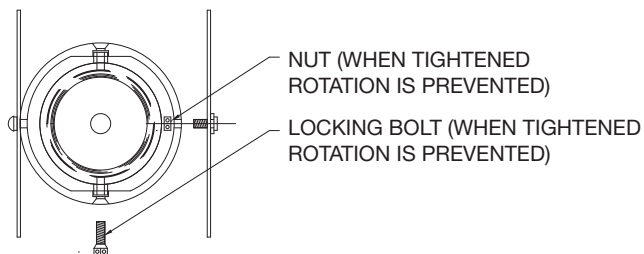

BOTTOM VIEW

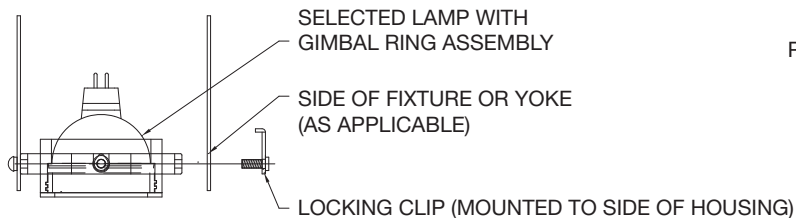

FRONT VIEW

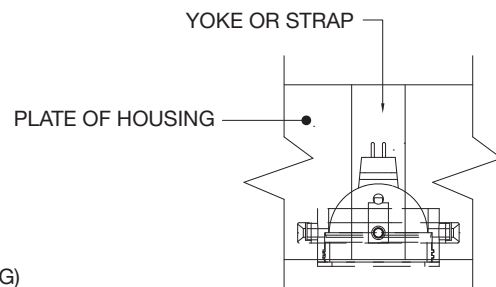

SIDE VIEW

Extendable Yokes

ADD -EY TO END OF MODEL NUMBER

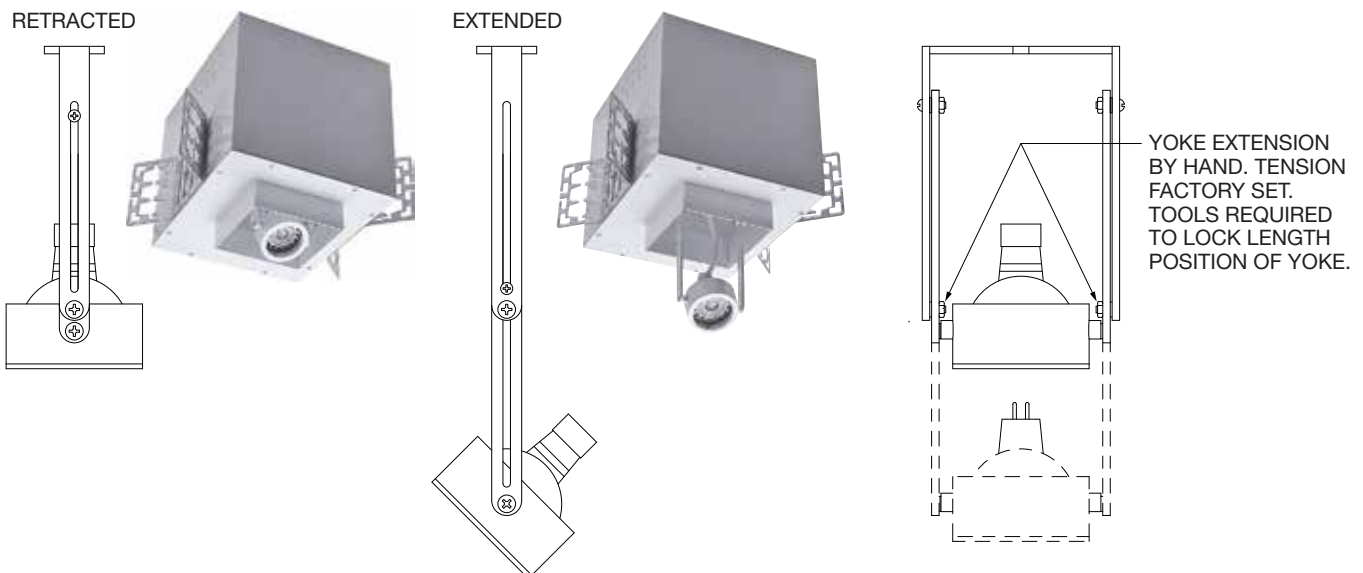

Modular Multiples®

Fixture Options

Modular accessories are used individually or in inventive combinations to shield brightness, reduce glare, vary beam patterns, retain direction, and alter color. Fixture option dimensions vary with lamp size.

Shielding Options

ADD SHIELDING OPTION CODE (BELOW) TO END OF MODEL NUMBER

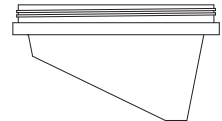
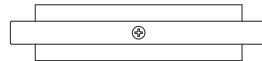

FILTER RING (STANDARD)

SHIELDING CONE (-SC)

SHIELDING CYLINDER (-CY)

WALL WASH CONE (-WWC)

Filter Media

ADD FILTER MEDIA CODE (BELOW) TO END OF MODEL NUMBER

LED modules accept one 1/8" thick filter. LED direct replacement and legacy lamps accept up to two 1/8" thick filters.

CLEAR GLASS (-CG)

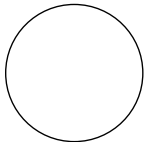

DIFFUSING SPREAD (-DS)

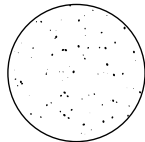

CUBE CELL LOUVER (-CL)

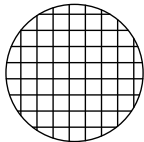

HEXCELL LOUVER (-HL)

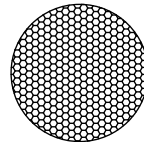

LINEAR SPREAD (-LS)

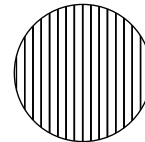

PRISMATIC WIDE SPREAD (-PS)

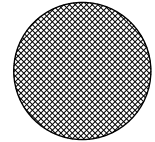

SATIN ETCHED (-SE)

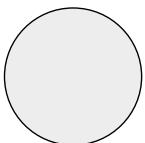

UV BLOCKING (-UB)

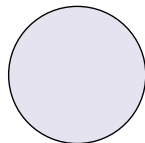

DICHROIC

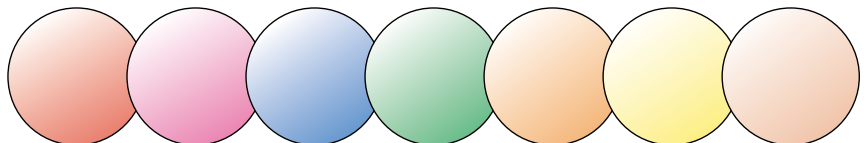

RED (-DR)

MAGENTA (-DM)

BLUE (-DB)

GREEN (-DG)

AMBER (-DA)

YELLOW (-DY)

PEACH (-DP)