

Modular Multiples®

Trimless TI

Transformer Incorporated - Recessed - New Work

A perforated flange around housing facilitates plastering flush with ceiling system, leaving an attractive trimless aperture. Fixtures feature a removable plate inside the housing, held in place with screws, providing access to the power supplies/ transformer. Fixtures must be installed with or prior to the ceiling system.

Four Lamp

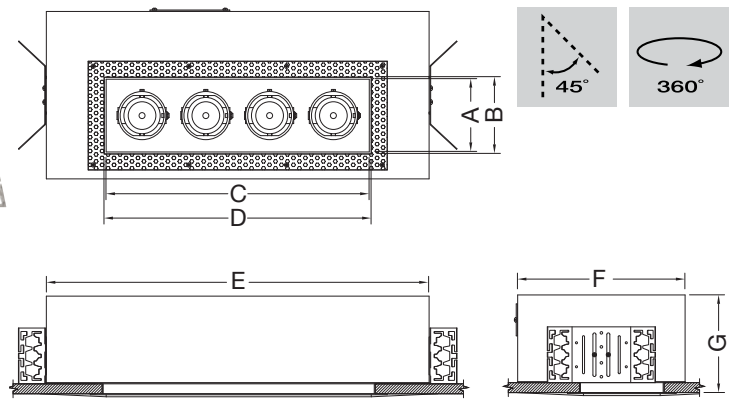

M4LED/306TI-REC-TL: Modular Multiples® Trimless Series, four 30 watt LED lamp modules, stainless steel housing, transformer incorporated, rectangular aperture, trimless configuration shown. Other configurations available.

LAMPS and DIMENSIONS	A	B	C	D	E	F	G
LED513 / MR16LED / MR16	4-9/16" 116mm	4-13/16" 122mm	1' 4-1/2" 419mm	1' 4-3/4" 425mm	2' 1-1/2" 648mm	10-1/2" 267mm	6-1/8" 156mm
LED708,716,720 / AR111LED / AR111	7-1/2" 191mm	7-3/4" 197mm	2' 4" 711mm	2' 4-1/4" 718mm	2' 7-1/2" 800mm	1' 1-3/4" 349mm	6-1/8" 156mm
PAR38LED / PAR38	7-1/2" 191mm	7-3/4" 197mm	2' 5-3/4" 756mm	2' 6" 762mm	2' 9-1/4" 845mm	1' 1-3/4" 349mm	10-7/16" 265mm

Modular Multiples®

Trimless TI

Transformer Incorporated - Recessed - New Work

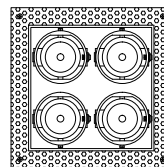
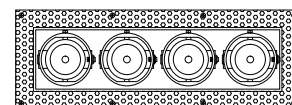
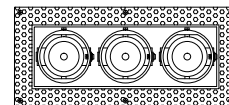
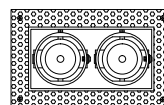
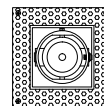

Configurations: 1, 2, 3, 4 light units standard, customs available

Housing: Fabricated 18 gauge steel housing with perforated spackle flange

Finishes:

- Powder coated - white or black standard
- Custom colors available
- Stainless steel / satin nickel available

Electrical:

- Internal electronic power supply(s) / transformer(s) / ballast(s)
- Dimmable (not applicable on HID products)
- One power supply / transformer per lamp allowing for multi-circuit wiring.
- 120v and 277v available
- Listed to UL1598 standards

Lamping: **Standard LED Modules**

13w LED-513-6	13w LED-513-12	13w LED-513-22
8w LED-708-6	8w LED-708-12	8w LED-708-22
16w LED-716-12	16w LED-716-22	16w LED-716-45
20w LED-720-12	20w LED-720-22	20w LED-720-45

Direct Replacement LED or Legacy Lamps:

MR16LED (-BLD)	MR16 HALOGEN (-B)	MR16CMH (-BH)
AR111LED (-DLD)	AR111 HALOGEN (-D)	CDMR111 (-S)
PAR30LED (-GLD)	PAR30 (-G)	PAR30HID (-H)
PAR38LED (-JLD)	PAR38 (-J)	PAR38HID (-K)

Mounting:

- For new construction applications.
- Recessed housing is installed via adjustable universal mounting brackets and bar hangers prior to the installation of drywall.
- Once drywall is installed, the Trimless Mounting Frame is secured to the housing.
- Spackling compound is applied over the perforated flange and finished for a smooth finished appearance.

Options:

- Patented die-cast aluminum ring sets and locking devices
- Pull down yokes
- Shielding cones
- Filter media
 - LED modules accept one 1/8" thick filter
 - LED direct replacement and legacy lamps accept up to two 1/8" thick filters

Model # example: **M 2 LED-513-6 x TI - REC - TL**

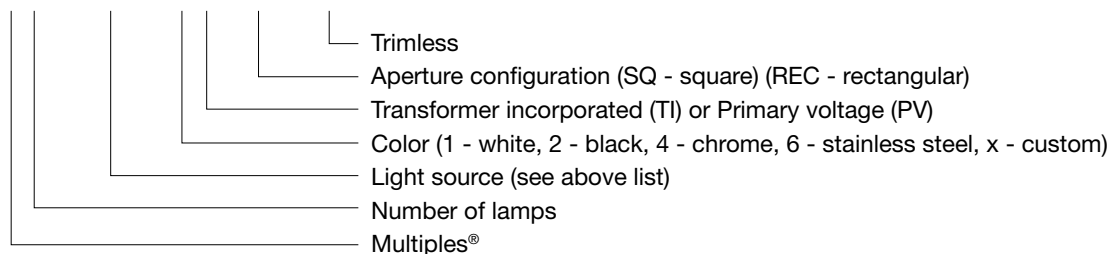

Modular Multiples®

Trimless TI Typical Installation

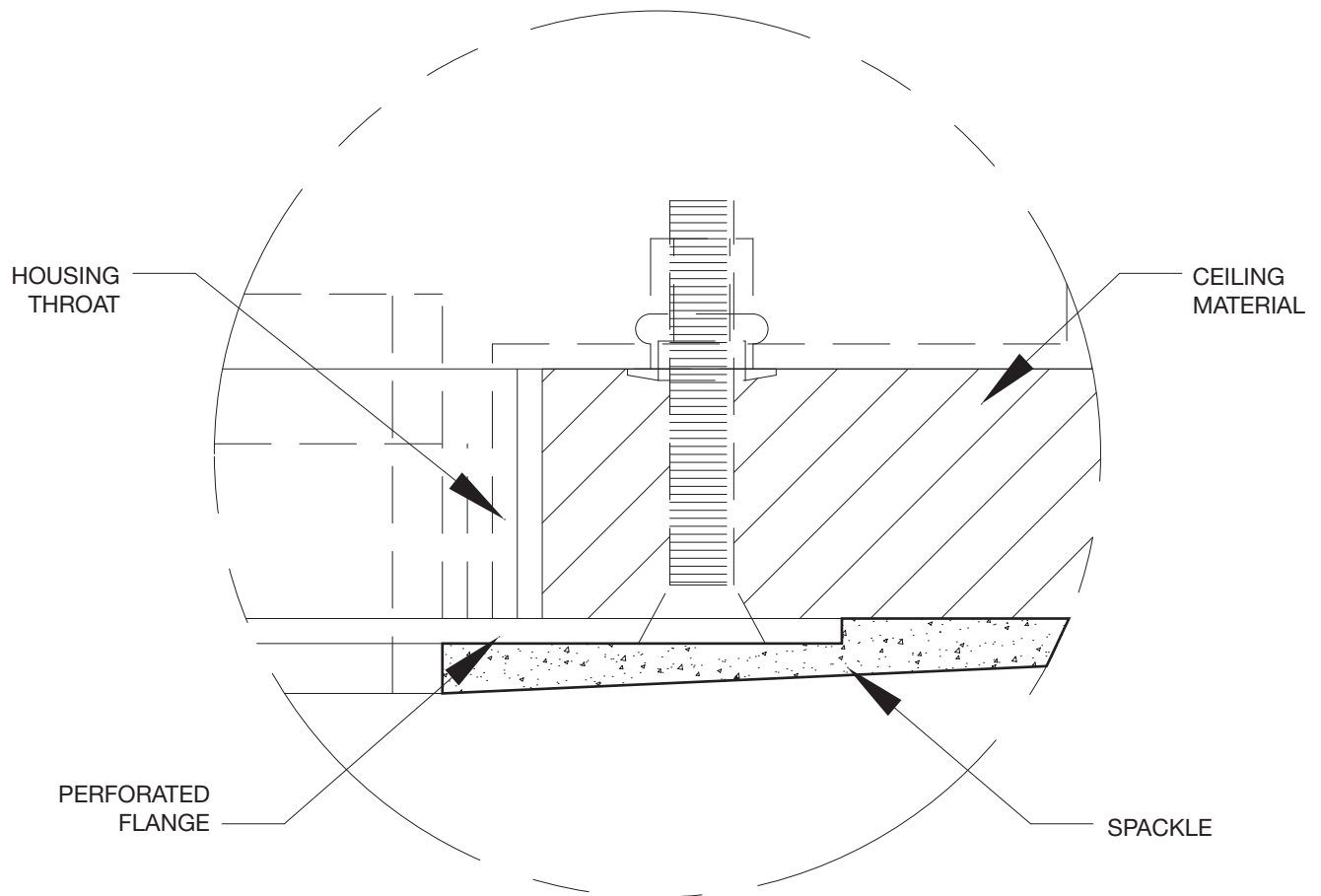

Modular Multiples®

Standard LED Modules

LED-513-6

623 Lumens 13w / 6° OPTICS / 2700°K

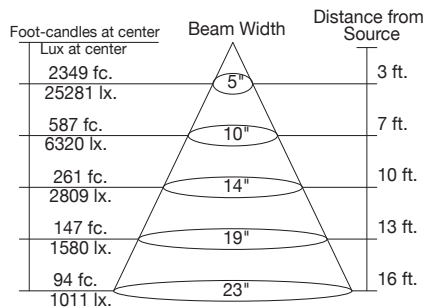

LED-708-6

465 Lumens 8w / 6° OPTICS / 2700°K

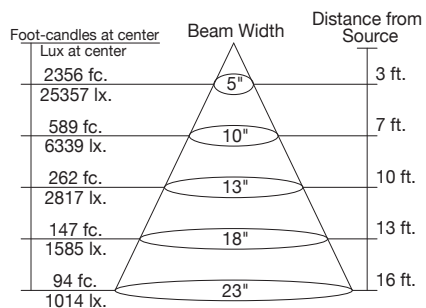

LED-716-12

1047 Lumens 16w / 12° OPTICS / 2700°K

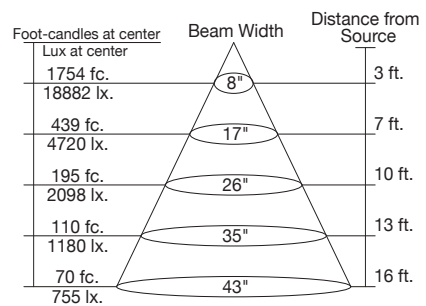

LED-720-12

1054 Lumens 20w / 12° OPTICS / 2700°K

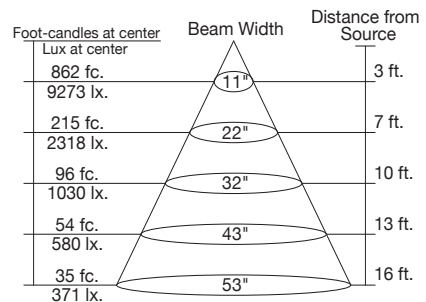

LED-513-12

598 Lumens 13w / 12° OPTICS / 2700°K

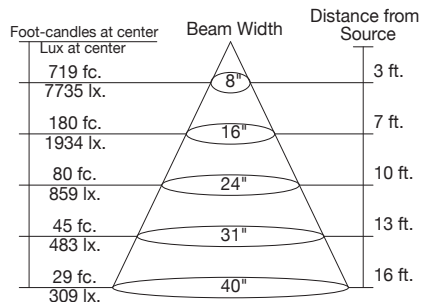

LED-708-12

626 Lumens 8w / 12° OPTICS / 2700°K

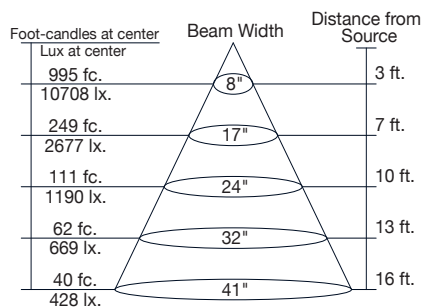

LED-716-22

1043 Lumens 16w / 22° OPTICS / 2700°K

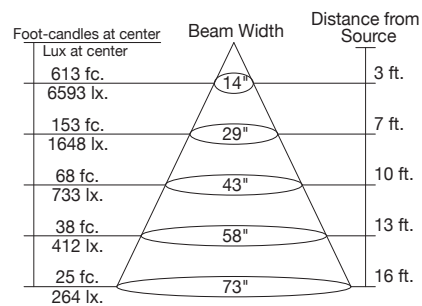

LED-720-22

1040 Lumens 20w / 22° OPTICS / 2700°K

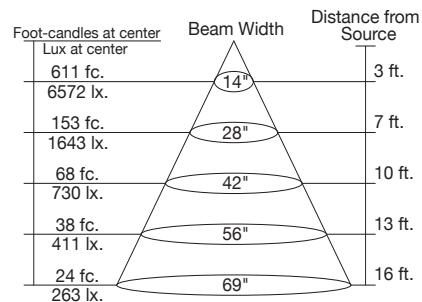

LED-513-22

630 Lumens 13w / 22° OPTICS / 2700°K

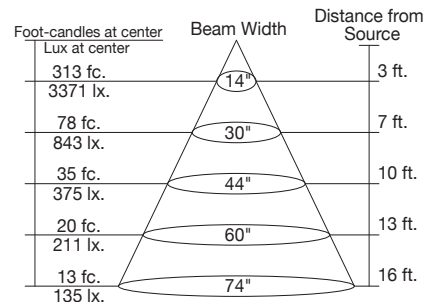

LED-708-22

613 Lumens 8w / 22° OPTICS / 2700°K

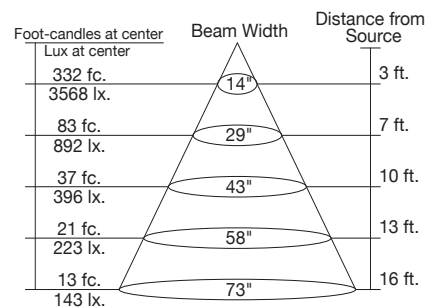

LED-716-45

980 Lumens 16w / 45° OPTICS / 2700°K

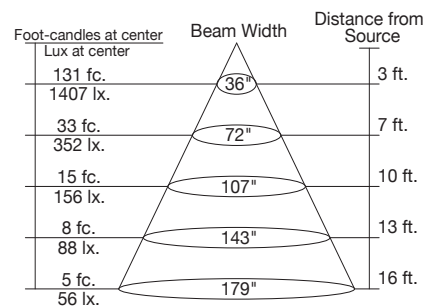

LED-720-45

1033 Lumens 20w / 45° OPTICS / 2700°K

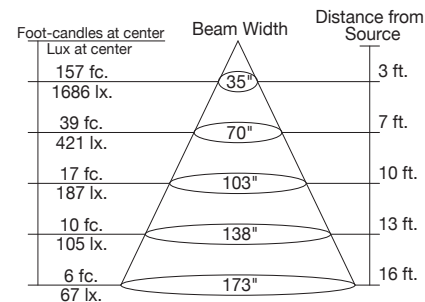

Modular Multiples®

Fixture Options

Modular accessories are used individually or in inventive combinations to shield brightness, reduce glare, vary beam patterns, retain direction, and alter color. Dimensions of all fixture options vary with lamp size.

Ring Sets and Locking Devices (PATENTED)

ADD -LM TO END OF MODEL NUMBER

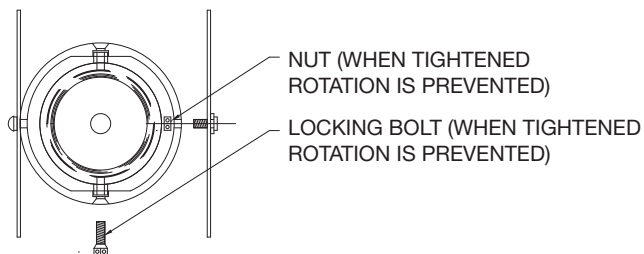

BOTTOM VIEW

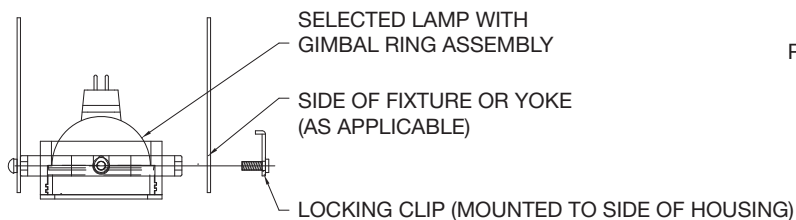

FRONT VIEW

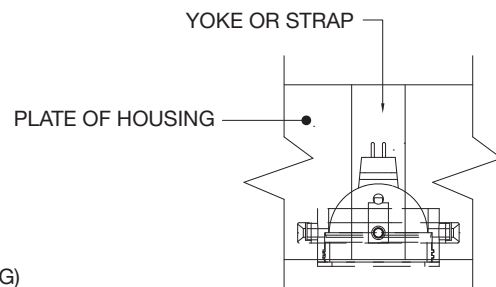

SIDE VIEW

Extendable Yokes

ADD -EY TO END OF MODEL NUMBER

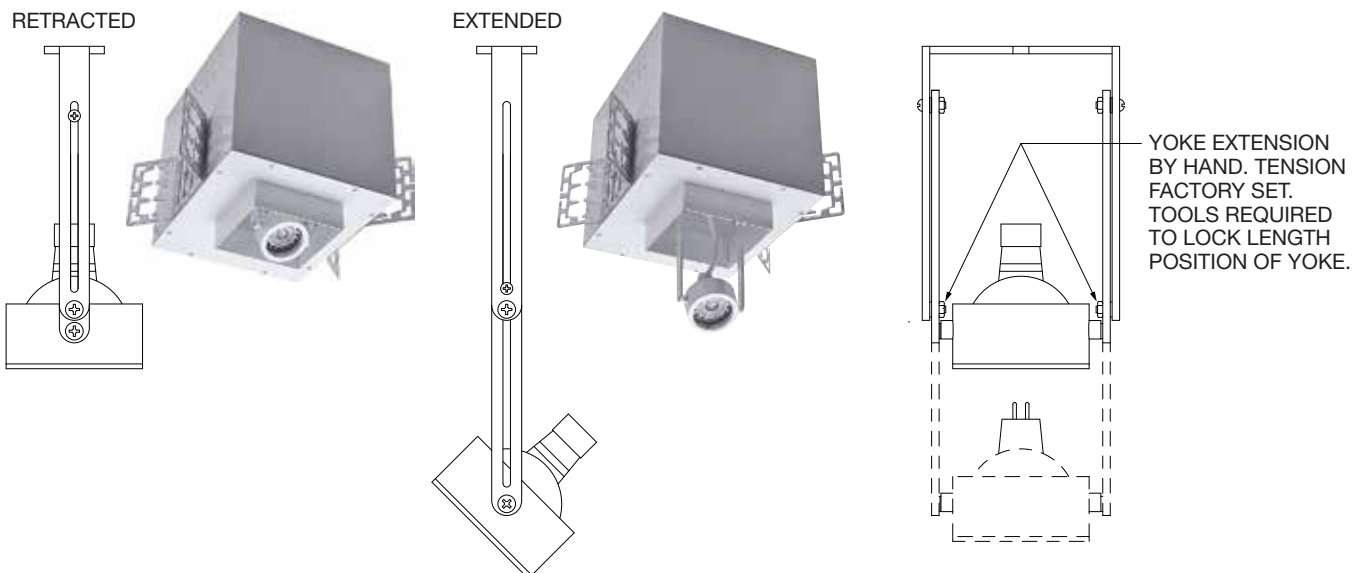

Modular Multiples®

Fixture Options

Modular accessories are used individually or in inventive combinations to shield brightness, reduce glare, vary beam patterns, retain direction, and alter color. Fixture option dimensions vary with lamp size.

Shielding Options

ADD SHIELDING OPTION CODE (BELOW) TO END OF MODEL NUMBER

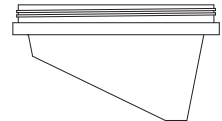
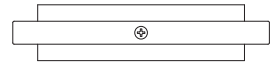
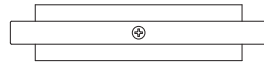
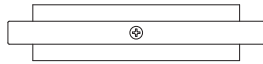
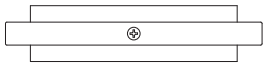

FILTER RING (STANDARD)

SHIELDING CONE (-SC)

SHIELDING CYLINDER (-CY)

WALL WASH CONE (-WWC)

Filter Media

ADD FILTER MEDIA CODE (BELOW) TO END OF MODEL NUMBER

LED modules accept one 1/8" thick filter. LED direct replacement and legacy lamps accept up to two 1/8" thick filters.

CLEAR GLASS (-CG)

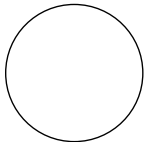

DIFFUSING SPREAD (-DS)

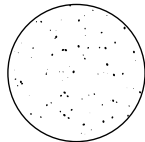

CUBE CELL LOUVER (-CL)

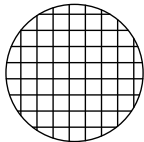

HEXCELL LOUVER (-HL)

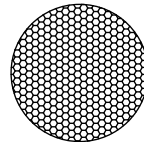

LINEAR SPREAD (-LS)

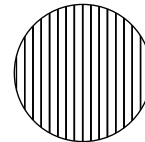

PRISMATIC WIDE SPREAD (-PS)

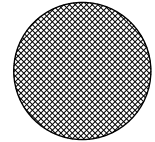

SATIN ETCHED (-SE)

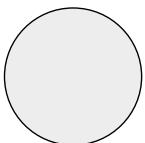

UV BLOCKING (-UB)

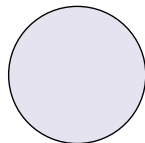

DICHROIC

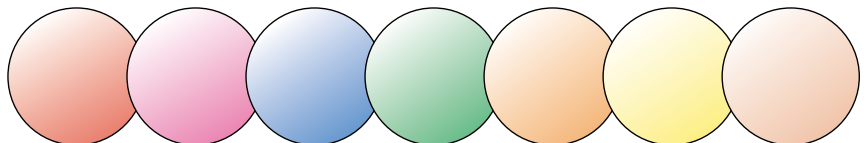

RED (-DR)

MAGENTA (-DM)

BLUE (-DB)

GREEN (-DG)

AMBER (-DA)

YELLOW (-DY)

PEACH (-DP)