

Modular Multiples®

Trimmed TI

Transformer Incorporated - Recessed - New Work

Built to your specifications, these high-quality fixtures feature a trimmed aperture for a clean, refined appearance. Available with transformer incorporated, transformer attached, and remote transformer configurations for new and old work installations. The series is adaptable to plaster, gyboard, wood, or acoustical ceilings. This series conforms to USA standards. A companion series that conforms to Asian and European standards is also available.

Four Lamp

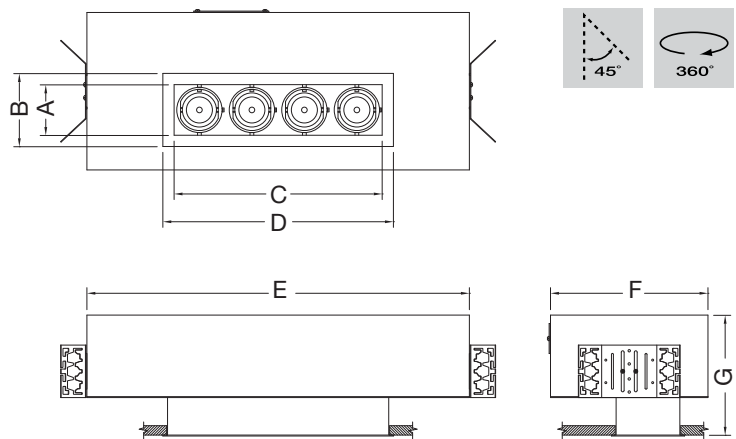

M4B2TI-REC-TR: Modular Multiples® Trimmed Series, four MR16 lamps, black housing, transformer incorporated, rectangular aperture, trimmed configuration shown. Other configurations available.

LAMPS and DIMENSIONS	A	B	C	D	E	F	G
LED513 / MR16LED / MR16	3-3/8" 86mm	4-7/8" 124mm	1' 1-7/8" 352mm	1'3-3/8" 391mm	2'1-1/2" 648mm	10-1/2" 267mm	8" 203mm
LED708,716,720 / AR111LED / AR111	7-1/4" 184mm	9-1/4" 235mm	2'4" 711mm	2'6" 762mm	2'7-1/2" 800mm	1'1-3/4" 349mm	8-1/2" 216mm
PAR38LED / PAR38	7-1/4" 184mm	9-1/4" 235mm	2'5-3/4" 756mm	2'7-3/4" 806mm	2'9" 838mm	1'1-3/4" 349mm	9-3/4" 248mm

Modular Multiples®

Trimmed TI

Transformer Incorporated - Recessed - New Work

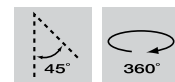
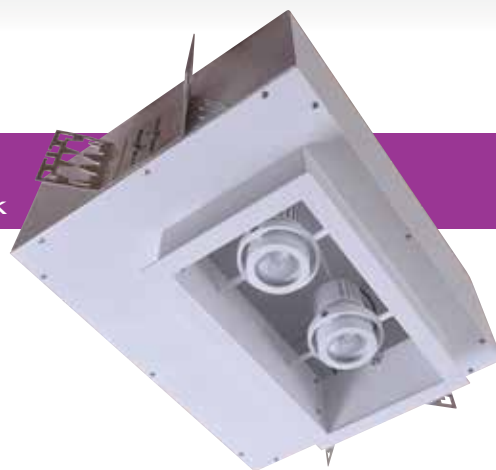

Configurations: 1, 2, 3, 4 light units standard, customs available

Housing:

- Fabricated 18 gauge steel supplied with adjustable mounting brackets
- 14 gauge steel trim flange
- Available for airtight or IC rated applications

Finishes:

- Powder coated - white or black standard
- Custom colors available
- Stainless steel / satin nickel available

Electrical:

- Electronic power supply(s) / transformer(s) / ballast(s)
- Dimmable (not applicable on HID products)
- One power supply / transformer per lamp allowing for multi-circuit wiring.
- 120v and 277v available
- Listed to UL1598 standards

Lamping:

Standard LED Modules

13w LED-513-6	13w LED-513-12	13w LED-513-22
8w LED-708-6	8w LED-708-12	8w LED-708-22
16w LED-716-12	16w LED-716-22	16w LED-716-45
20w LED-720-12	20w LED-720-22	20w LED-720-45

Direct Replacement LED or Legacy Lamps:

MR16LED (-BLD)	MR16 HALOGEN (-B)	MR16CMH (-BH)
AR111LED (-DL D)	AR111 HALOGEN (-D)	CDMR111 (-S)
PAR30LED (-GLD)	PAR30 (-G)	PAR30HID (-H)
PAR38LED (-JLD)	PAR38 (-J)	PAR38HID (-K)

Mounting:

- For new construction applications.
- Recessed housing is installed via adjustable universal mounting brackets and bar hangers prior to the installation of drywall.
- Fixture designed for use in ceiling material with a maximum thickness of 2"

Options:

- Patented die-cast aluminum ring sets and locking devices
- Pull down yokes
- Shielding cones
- Filter media
 - LED modules accept one 1/8" thick filter
 - LED direct replacement and legacy lamps accept up to two 1/8" thick filters

Model # example: M 2 LED-513-6 x TI - REC - TR

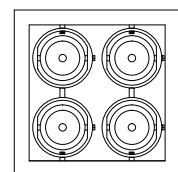
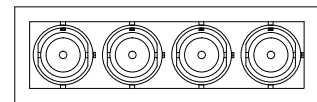
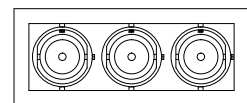
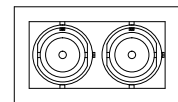
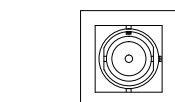
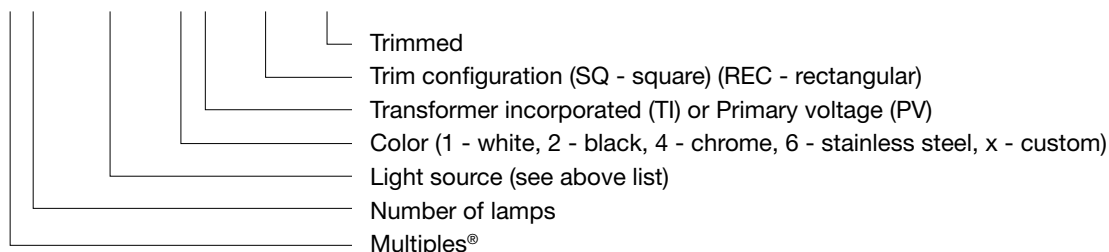

Modular Multiples®

Trimmed TI Typical Installation

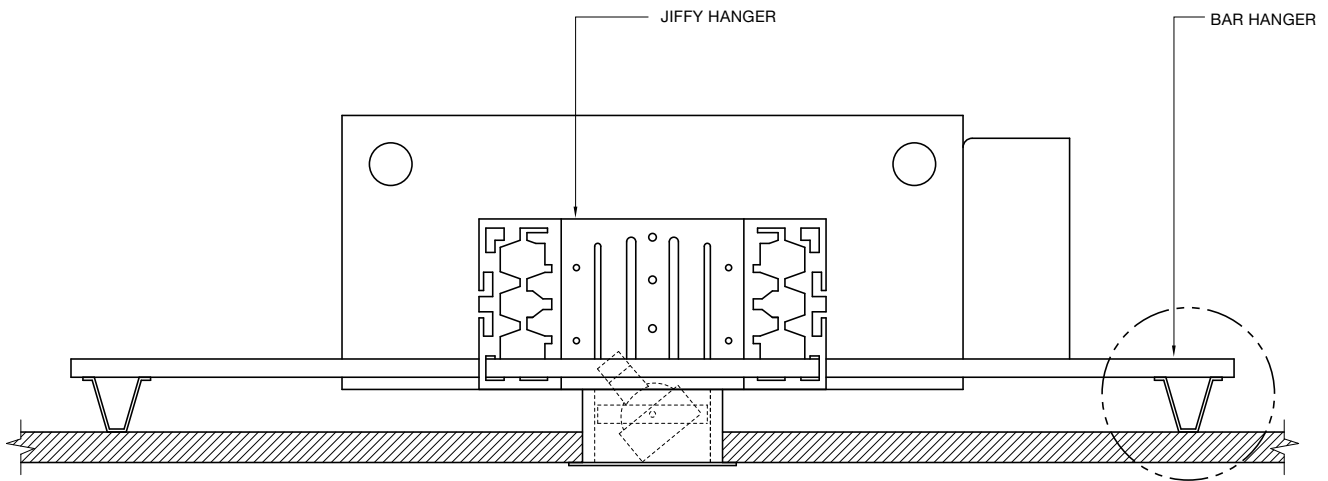
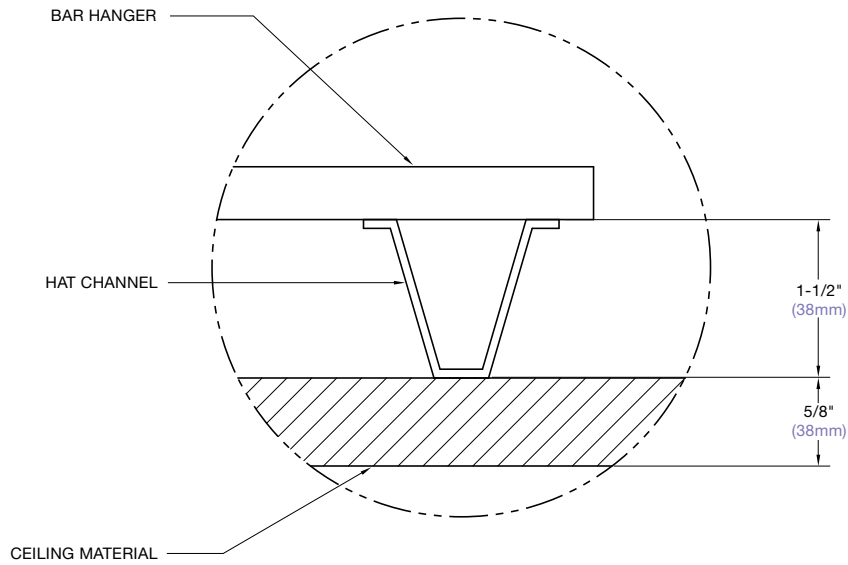

Modular Multiples®

Standard LED Modules

LED-513-6

623 Lumens 13w / 6° OPTICS / 2700°K

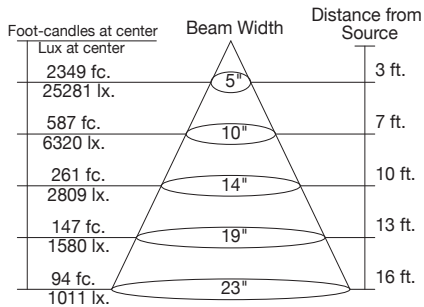

LED-708-6

465 Lumens 8w / 6° OPTICS / 2700°K

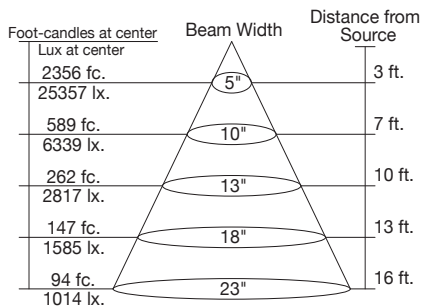

LED-716-12

1047 Lumens 16w / 12° OPTICS / 2700°K

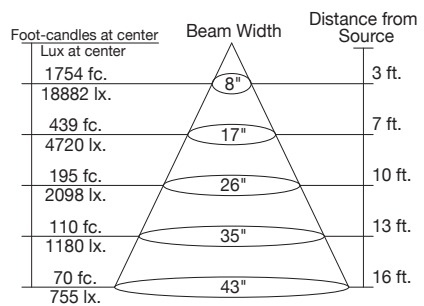

LED-720-12

1054 Lumens 20w / 12° OPTICS / 2700°K

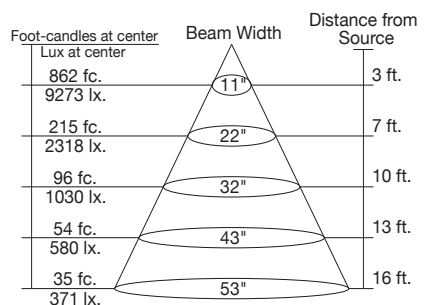

LED-513-12

598 Lumens 13w / 12° OPTICS / 2700°K

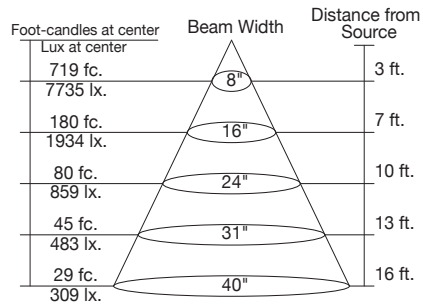

LED-708-12

626 Lumens 8w / 12° OPTICS / 2700°K

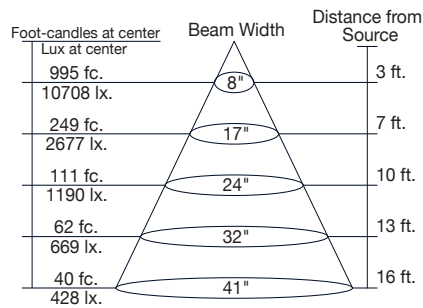

LED-716-22

1043 Lumens 16w / 22° OPTICS / 2700°K

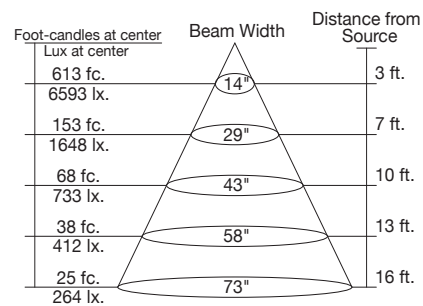

LED-720-22

1040 Lumens 20w / 22° OPTICS / 2700°K

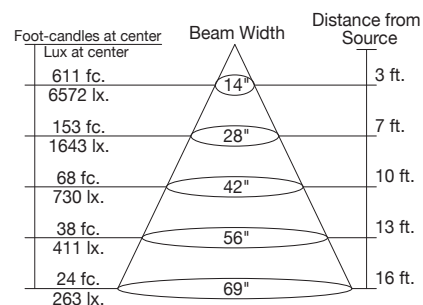

LED-513-22

630 Lumens 13w / 22° OPTICS / 2700°K

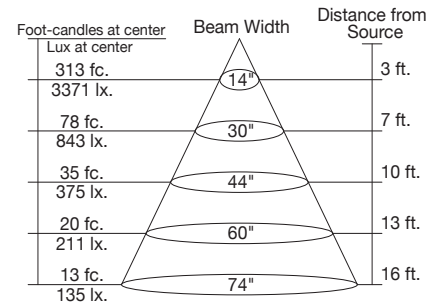

LED-708-22

613 Lumens 8w / 22° OPTICS / 2700°K

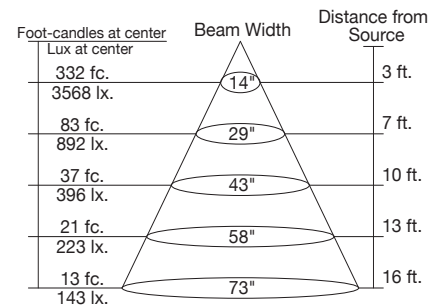

LED-716-45

980 Lumens 16w / 45° OPTICS / 2700°K

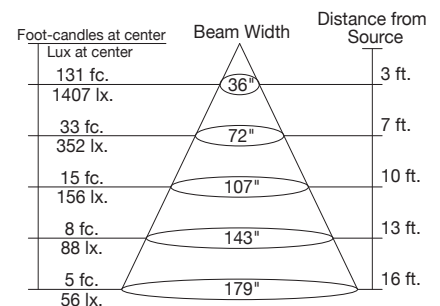

LED-720-45

1033 Lumens 20w / 45° OPTICS / 2700°K

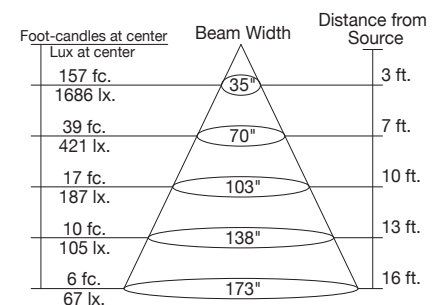

Modular Multiples®

Fixture Options

Modular accessories are used individually or in inventive combinations to shield brightness, reduce glare, vary beam patterns, retain direction, and alter color. Dimensions of all fixture options vary with lamp size.

Ring Sets and Locking Devices (PATENTED)

ADD -LM TO END OF MODEL NUMBER

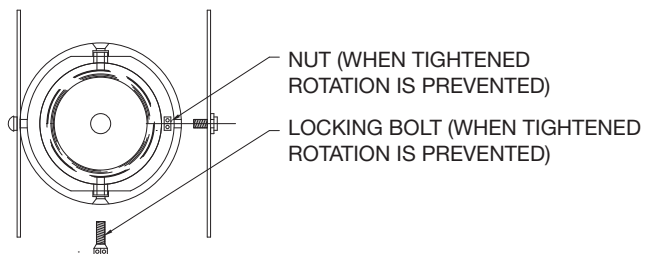

BOTTOM VIEW

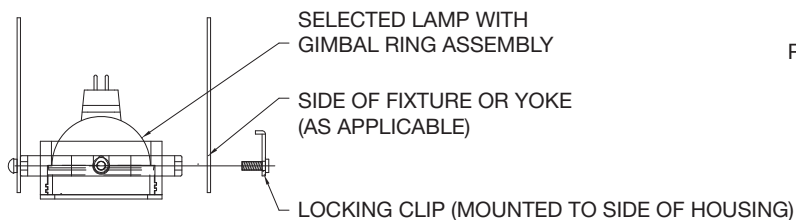

FRONT VIEW

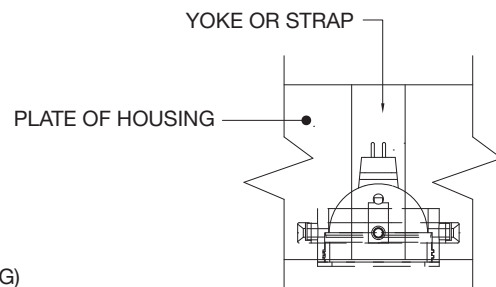

SIDE VIEW

Extendable Yokes

ADD -EY TO END OF MODEL NUMBER

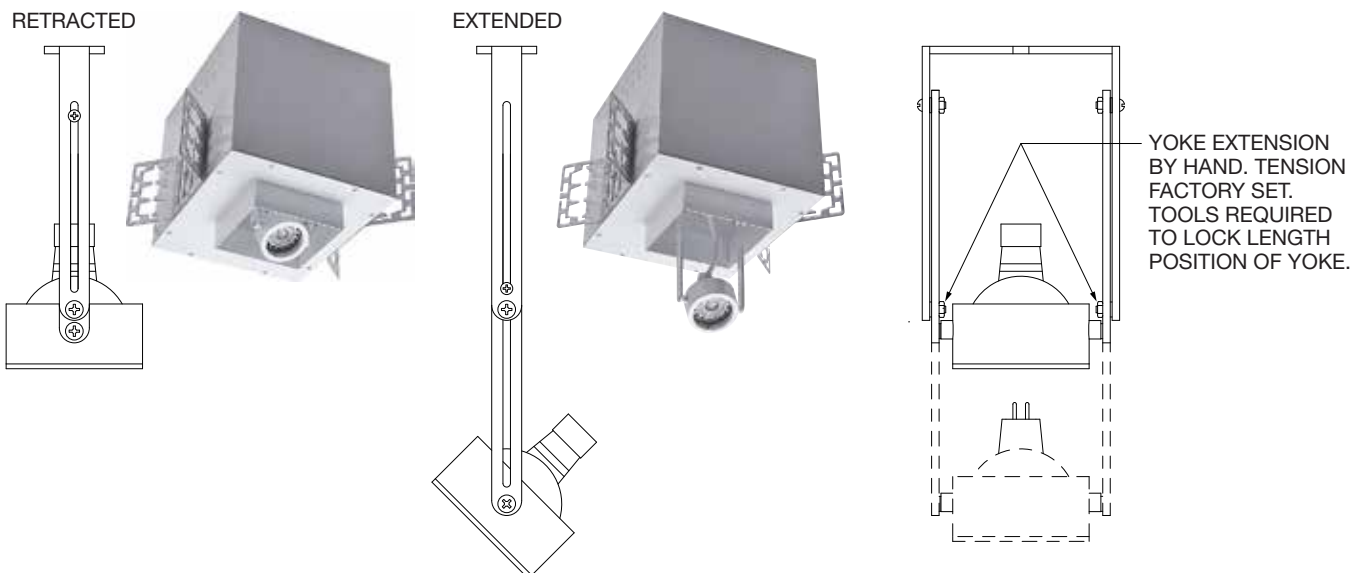

Modular Multiples®

Fixture Options

Modular accessories are used individually or in inventive combinations to shield brightness, reduce glare, vary beam patterns, retain direction, and alter color. Fixture option dimensions vary with lamp size.

Shielding Options

ADD SHIELDING OPTION CODE (BELOW) TO END OF MODEL NUMBER

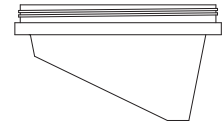
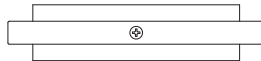

FILTER RING (STANDARD)

SHIELDING CONE (-SC)

SHIELDING CYLINDER (-CY)

WALL WASH CONE (-WWC)

Filter Media

ADD FILTER MEDIA CODE (BELOW) TO END OF MODEL NUMBER

LED modules accept one 1/8" thick filter. LED direct replacement and legacy lamps accept up to two 1/8" thick filters.

CLEAR GLASS (-CG)

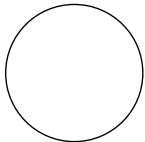

DIFFUSING SPREAD (-DS)

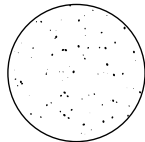

CUBE CELL LOUVER (-CL)

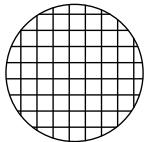

HEXCELL LOUVER (-HL)

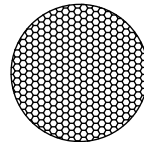

LINEAR SPREAD (-LS)

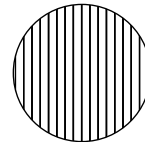

PRISMATIC WIDE SPREAD (-PS)

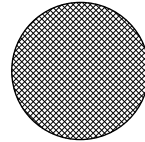

SATIN ETCHED (-SE)

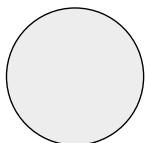

UV BLOCKING (-UB)

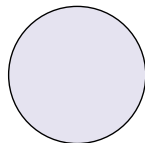

DICHROIC

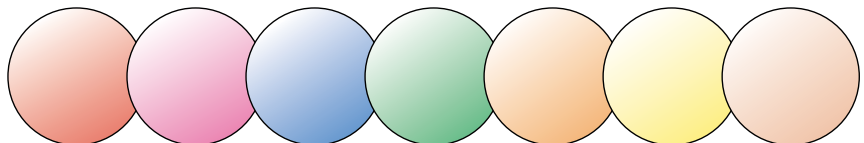

RED (-DR)

MAGENTA (-DM)

BLUE (-DB)

GREEN (-DG)

AMBER (-DA)

YELLOW (-DY)

PEACH (-DP)